

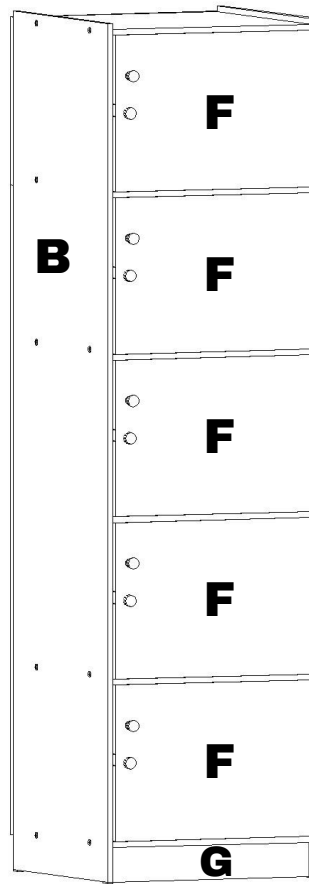









# MANUAL RAKIT RSG-1402 GL



## AKSESORIS

NO	PICTURE	QTY	CHECKLIST
1	 DUPLO	10	
2	 OLIMPIC 8 X 2	18	
3	 PAKU	35	
4	 FH 6X1/2	34	
5	 BAUT HANDLE	5	
6	 L GRENDEL	5	
7	 DOWEL	12	
8	 KUNCI	5	
9	 KAKI	4	
10	 HANDLE KNOP	5	

## KOMPONEN PANEL

CODE	NAME	CHECKLIST
A	TOP	
B	KA KN	
C	KA KR	
D	ALAS	
E	AMBALAN	
F	PINTU	
G	SDG BAWAH	
H	TRIPLEK 1	
I	TRIPLEK 2	

MANUAL BOOK  
GRACE RSG-1402 GL

SCAN DISINI !!



\*MOHON MELAKUKAN PENGECEKAN SEBELUM MERAKIT

**1**

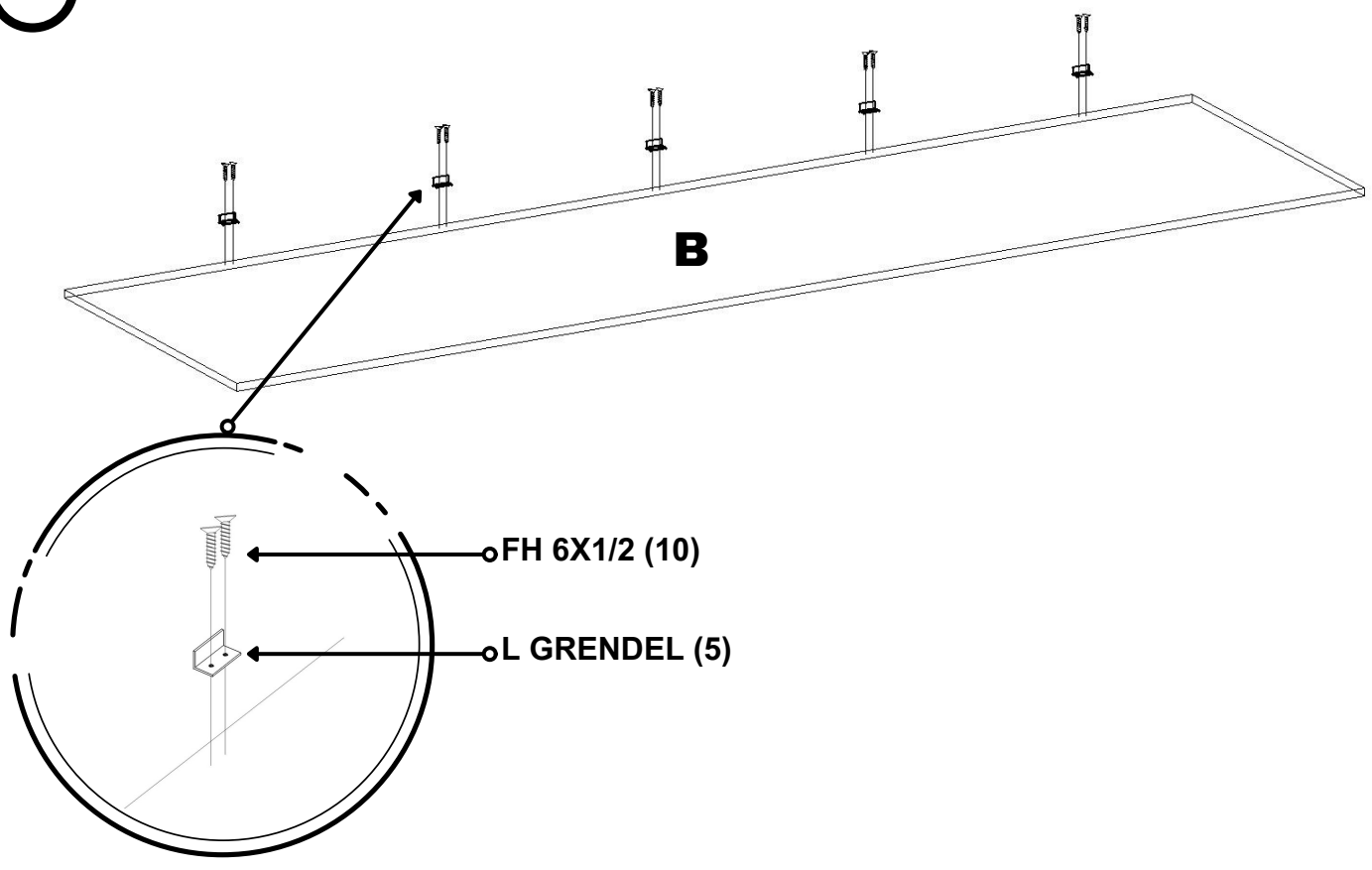

**2**

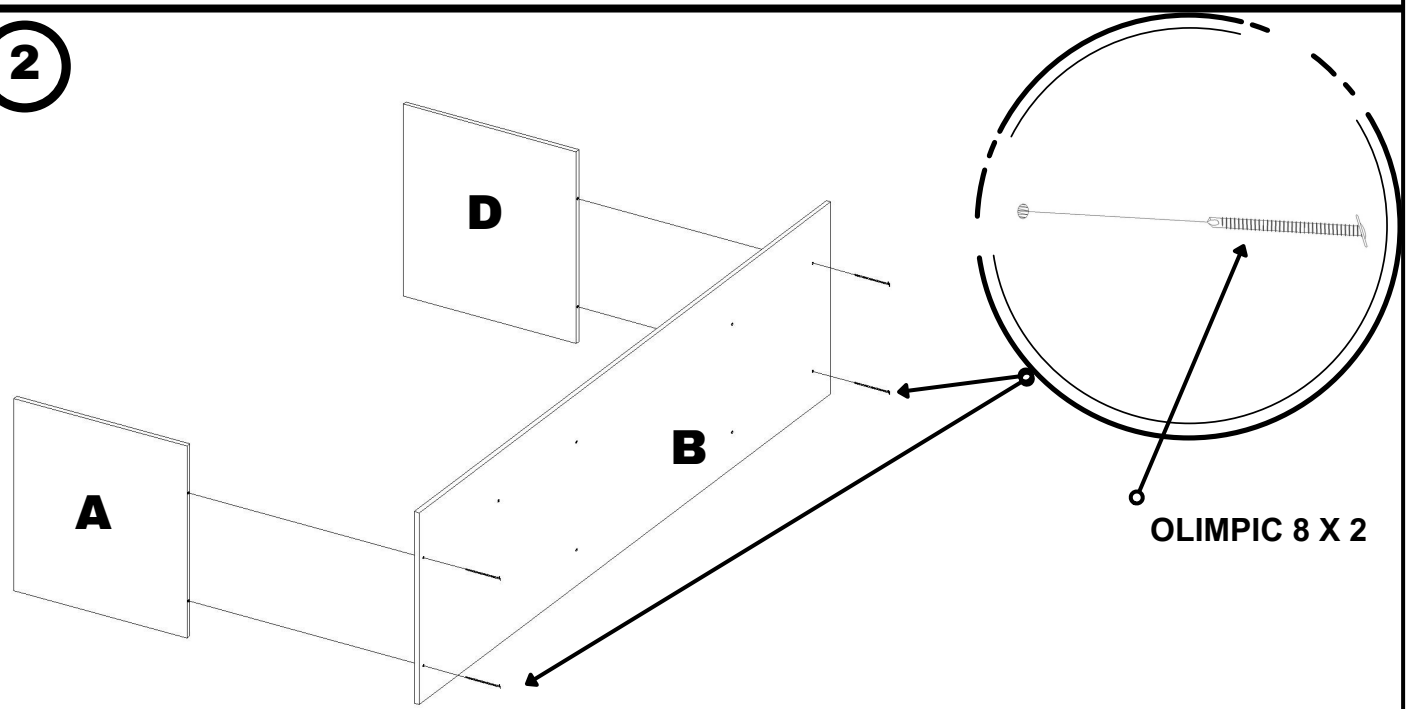

3

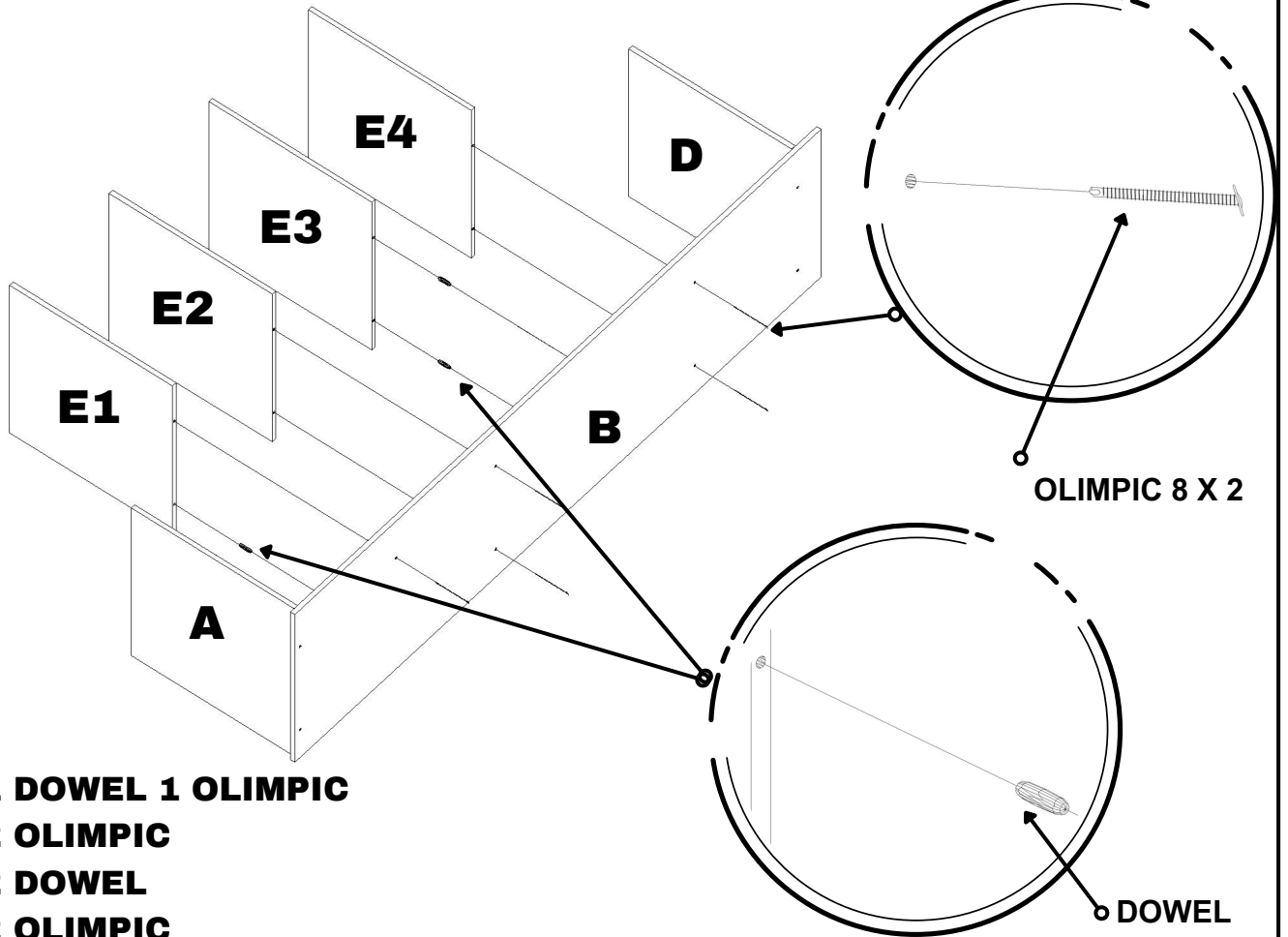

- E1 : 1 DOWEL 1 OLIMPIC**
- E2 : 2 OLIMPIC**
- E3 : 2 DOWEL**
- E4 : 2 OLIMPIC**

4

**#Note : Pemasangan Baut FH ke kunci jangan terlalu kencang & memakai 2 Baut FH Cukup ( seperti pada gambar )**

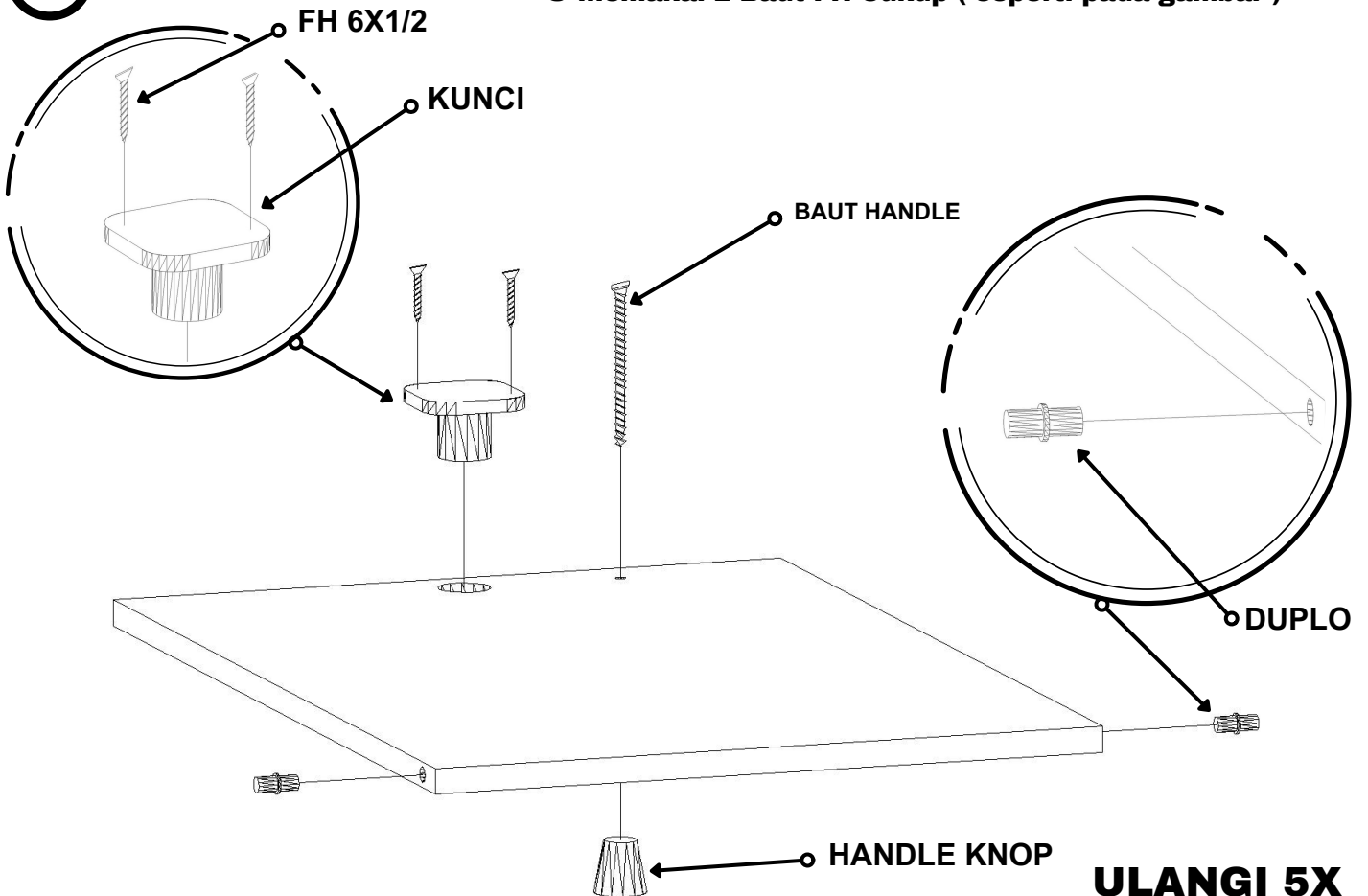

**ULANGI 5X**

5

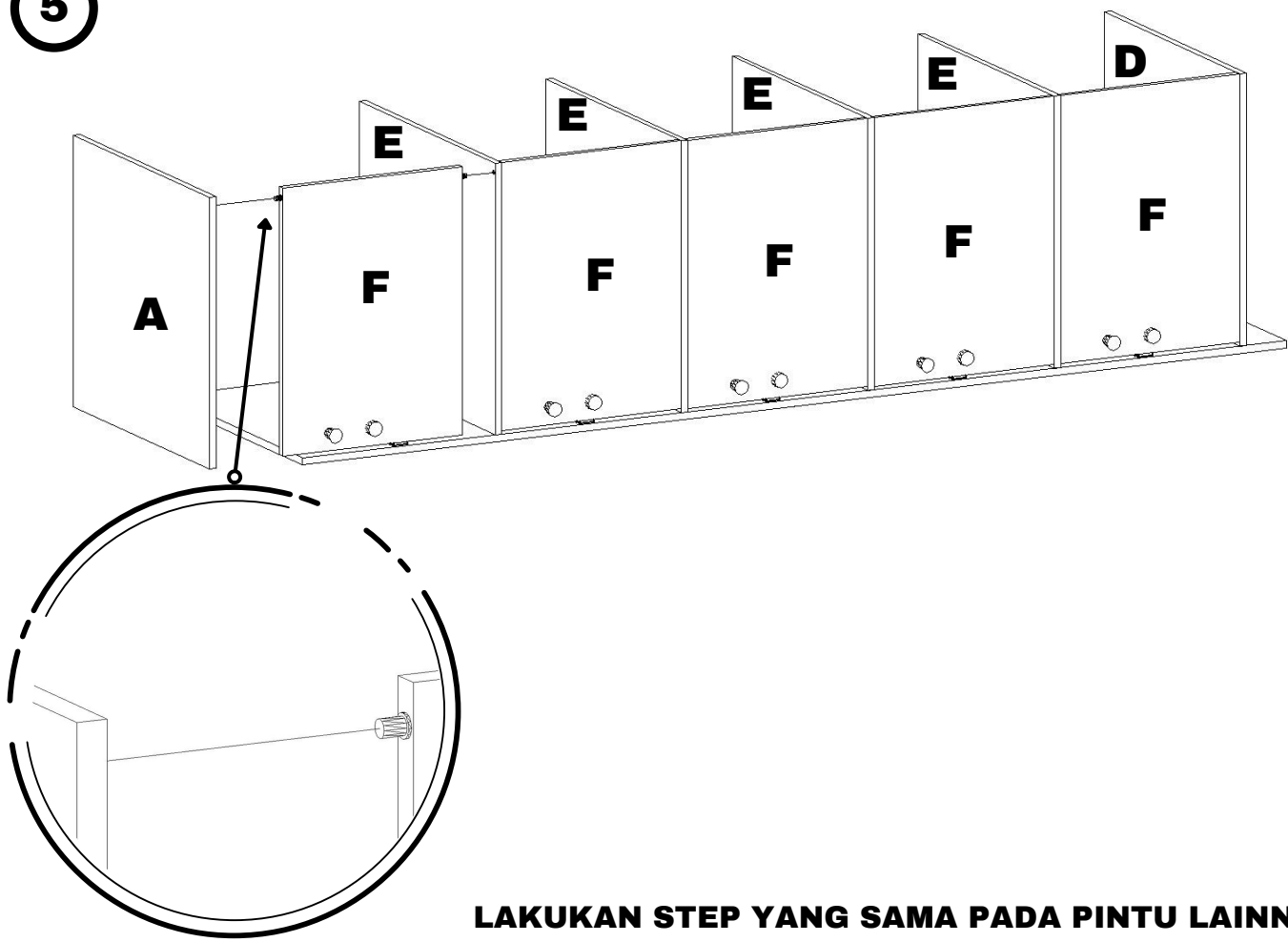

LAKUKAN STEP YANG SAMA PADA PINTU LAINNYA

6

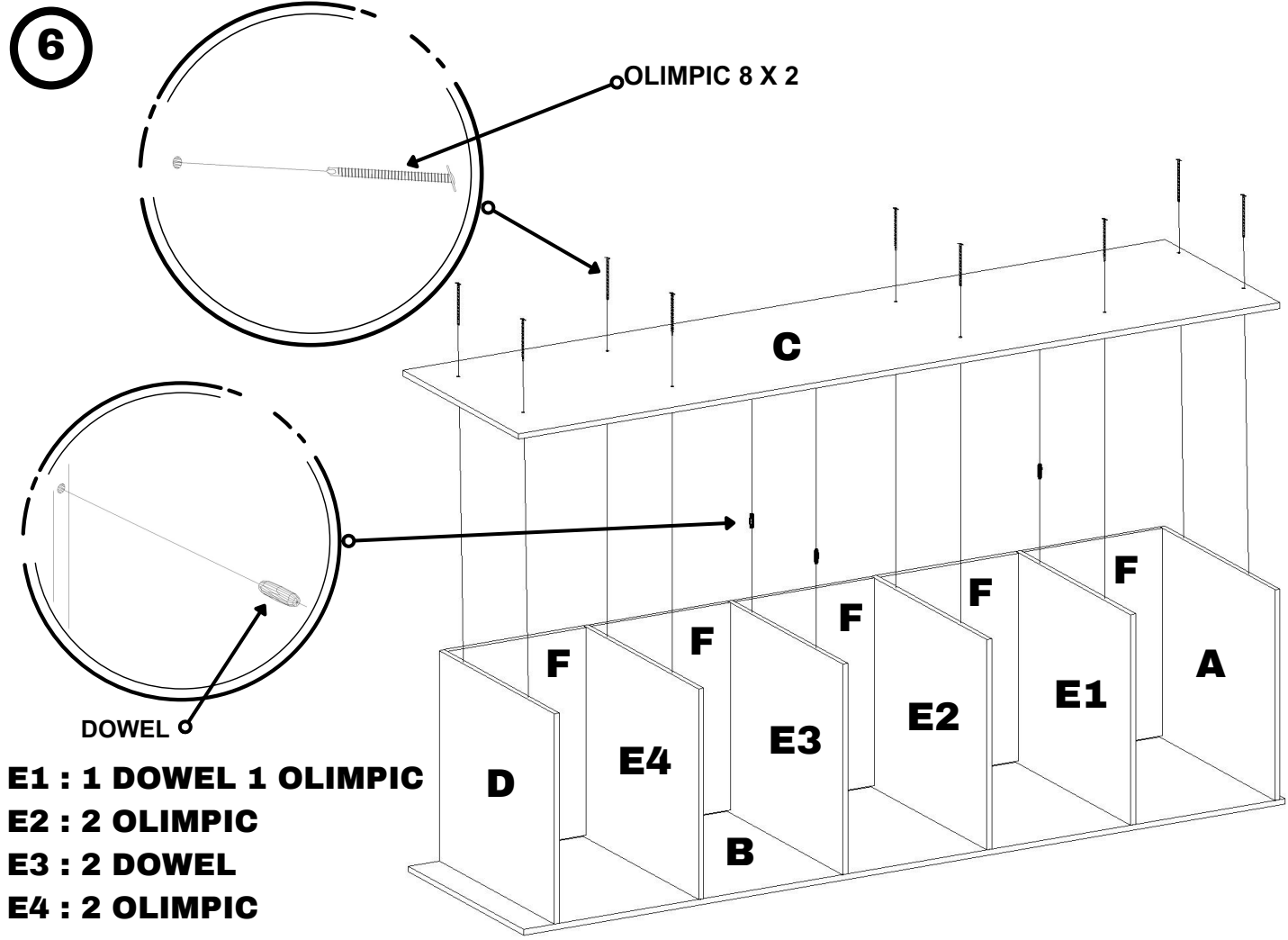

OLIMPIC 8 X 2

DOWEL

- E1 : 1 DOWEL 1 OLIMPIC
- E2 : 2 OLIMPIC
- E3 : 2 DOWEL
- E4 : 2 OLIMPIC

7

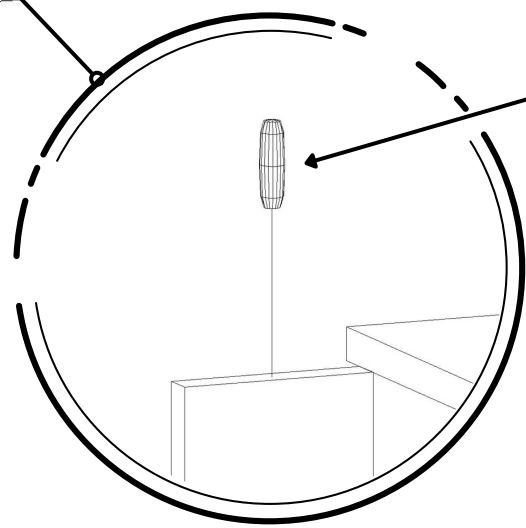
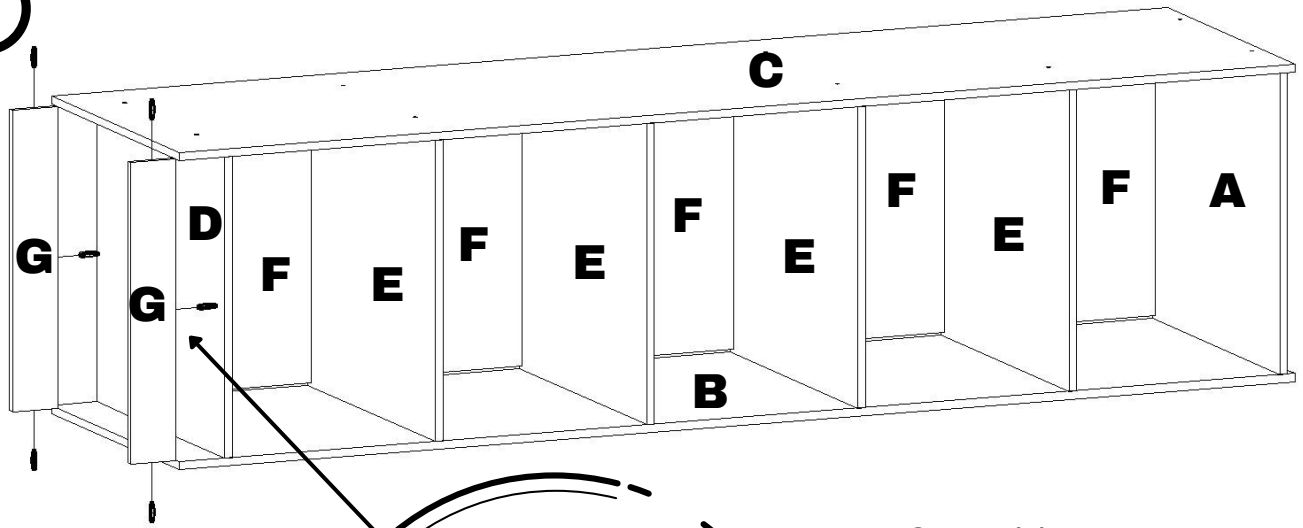

DOWEL (6)

8

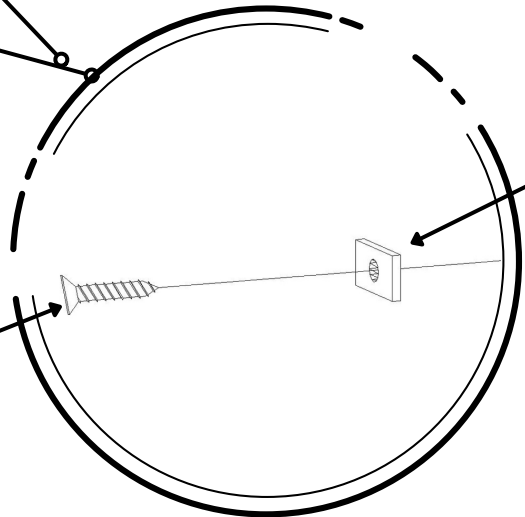
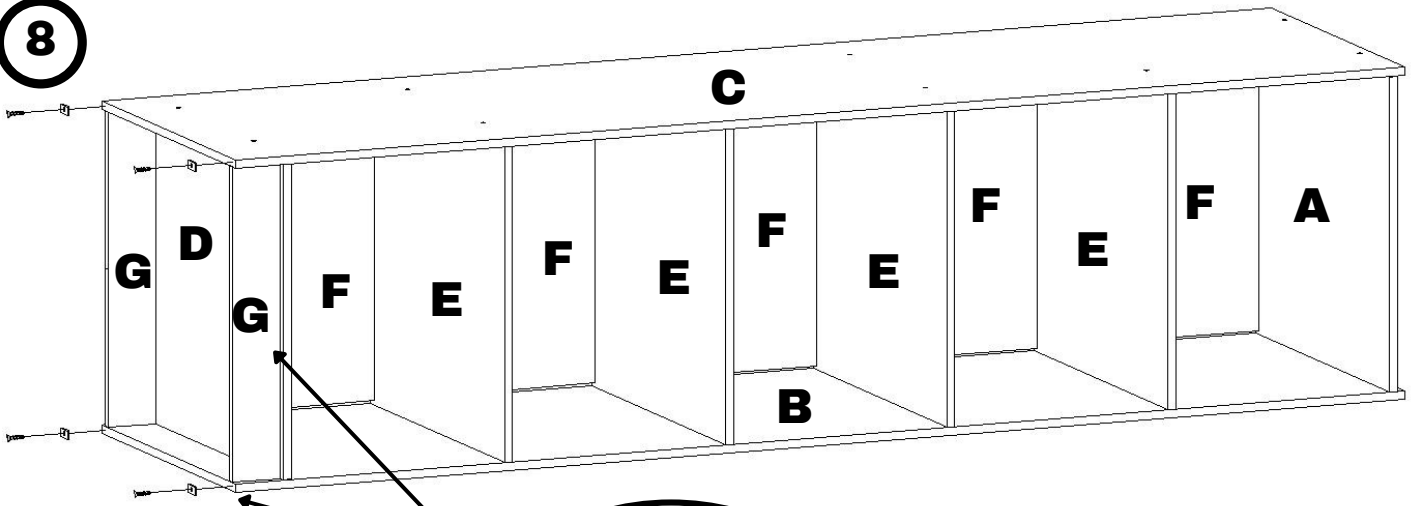

KAKI (4)

FH 6X1/2 (4)

9

